

A Stochastic Multi-Agent Optimization Model for Energy Infrastructure Planning Under Uncertainty and Competition

July 2017

A Research Report from the National Center for Sustainable Transportation

Zhaomiao Guo, University of California, Davis

Yueyue Fan, University of California, Davis



National Center
for Sustainable
Transportation



ITS UC DAVIS
INSTITUTE OF TRANSPORTATION STUDIES

About the National Center for Sustainable Transportation

The National Center for Sustainable Transportation is a consortium of leading universities committed to advancing an environmentally sustainable transportation system through cutting-edge research, direct policy engagement, and education of our future leaders. Consortium members include: University of California, Davis; University of California, Riverside; University of Southern California; California State University, Long Beach; Georgia Institute of Technology; and University of Vermont. More information can be found at: ncst.ucdavis.edu.

U.S. Department of Transportation (USDOT) Disclaimer

The contents of this report reflect the views of the authors, who are responsible for the facts and the accuracy of the information presented herein. This document is disseminated under the sponsorship of the United States Department of Transportation's University Transportation Centers program, in the interest of information exchange. The U.S. Government assumes no liability for the contents or use thereof.

Acknowledgments

This study was funded by a grant from the National Center for Sustainable Transportation (NCST), supported by USDOT through the University Transportation Centers program. The authors would like to thank the NCST and USDOT for their support of university-based research in transportation, and especially for the funding provided in support of this project.

A Stochastic Multi-Agent Optimization Model for Energy Infrastructure Planning Under Uncertainty and Competition

A National Center for Sustainable Transportation Research Report

July 2017

Zhaomiao Guo, Department of Civil and Environmental Engineering, University of California, Davis

Yueyue Fan, Department of Civil and Environmental Engineering, University of California, Davis



[page left intentionally blank]

TABLE OF CONTENTS

Abstract	1
Introduction	1
Mathematical Model and Analyses	3
A Stochastic Multi-agent Optimization Modeling Framework	3
Detailed Formulation for Each Decision Entity	5
Scenario Decomposition	9
Analyzing Each Scenario-Dependent Problem	10
Numerical Examples	18
A Simple Example for Illustration and Solution Validation	18
A Realistic Case Study Based on SMUD Power Network	21
Discussion	24
References	25
Appendix 1: Subroutine Pseudocode	28
Appendix 2: Data for Example 2	29

A Stochastic Multi-agent Optimization Model for Energy Infrastructure Planning under Uncertainty and Competition

Zhaomiao Guo^a, Yueyue Fan^{a,*}

^a*Department of Civil and Environmental Engineering
University of California Davis, CA 95616*

Abstract

This paper presents a stochastic multi-agent optimization model that supports energy infrastructure planning under uncertainty. The interdependence between different decision entities in the system is captured in an energy supply chain network, where new entrants of investors compete among themselves and with existing generators for natural resources, transmission capacities, and demand markets. Directly solving the stochastic energy supply chain planning problem is challenging. Through decomposition and reformulation, we convert the original problem to many traffic network equilibrium problems, which enables efficient solution algorithm design.

Keywords: energy supply chain, oligopolistic market, equilibrium, stochastic multi-agent optimization, decomposition

1. INTRODUCTION

Renewable energy sources (e.g. wind, solar, bioenergy, etc.) have catapulted to the forefront of the energy, environment, and national security debate. Many countries, especially the United States, have passed aggressive renewable portfolio standards (such as California's Renewables Portfolio Standard, EPAAct2005 Renewable Fuel Standard, and the presidential initiative), requiring renewable resources to produce anywhere between 20% - 33% of the electricity usage. It is less clear that the infrastructure systems needed to produce and deliver renewable energy will be in place to meet these standards in an efficient and sustainable manner. One of the roadblocks in meeting these standards is the complexity associated with renewable energy infrastructure systems, brought by the correlations and interactions between three major components: natural phenomena, renewable energy production systems, and current infrastructures (e.g. electricity grid). Critical to gaining a better understanding of this complexity is the ability to model the

*(Corresponding Author) Professor, Department of Civil and Environmental Engineering, University of California, Davis, CA 95616. Phone: 530-754-6408, Fax: 530-752-7872, Email: yyfan@ucdavis.edu

close coupling between these components so that effective energy planning decisions can be made at a system level.

15 To this end, several modeling challenges need to be addressed. First of all, a power supply system often involves non-cooperative behaviors of multiple decision entities. Typically, there are multiple generation companies supplying electricity to a region’s electricity grid, which is usually operated by a separate non-profit Independent System Operator (ISO). ISO is in charge of coordinating, controlling and monitoring the operation of the electrical system in order to
20 keep stability and efficiency of the network and instantaneously balance supply and demand (CalISO, 2013). Capturing the interactive behaviors of different system players simultaneously presents a great modeling challenge. Secondly, the physical infrastructure facilities for producing and delivering energy are also interdependent due to their spatial and functional correlations (Rinaldi et al., 2001). This requires a “supply chain” framework that considers the entire energy
25 path from an energy feedstock resource to the end users. Coping with uncertainty is another major challenge. Renewable energies, compared with conventional fuels, face more uncertainties in future feedstock supply, due to unpredictable weather conditions and changing regulations and policies (Lew and Piwko, 2010). Despite of the importance of addressing uncertainties in renewable energy supply system planning as identified in (IEA, 2006), very few stochastic
30 models exist in renewable energy infrastructure planning literature.

Regarding non-cooperative behaviors among multiple decision entities, several stochastic oligopolistic models exist in the energy modeling literature, such as (Genc et al., 2007; Pineau and Murto, 2003). These models are non-spatial in the sense that the network structure of the electricity supply system is not incorporated. There are also studies approaching from an
35 energy supply chain perspective, mainly contributed by Nagurney and coauthors. For example, Nagurney (2006) and Nagurney et al. (2007) showed that a supply chain network equilibrium problem is equivalent to a traffic network equilibrium problem by using the concept of super network structure and variational inequalities. Matsypura et al. (2007) modeled the operations of both renewable and nonrenewable fuel suppliers in a supply chain network. Liu and Nagurney
40 (2009) developed an integrated approach for modeling electricity and other types of fuel markets simultaneously while considering both the economic transaction and the physical transmission of energy flow over the supply chain network. Liu and Nagurney (2011) proposed an analytical model for energy firm merging and acquisition through supply chain network integration. Most of these past studies were based on deterministic approaches, assuming perfect foresight of
45 model input parameters. A recent paper by Liu and Nagurney (2013) extended their methods

to include demand and cost uncertainty in power market operation using a two-stage stochastic programming framework.

In this paper, we establish a stochastic multi-agent optimization model that supports long-term renewable infrastructure planning. Rather than emphasizing on operational decisions as in most power supply chain studies (Nagurney, 2006; Nagurney and Matsypura, 2007; Liu and Nagurney, 2007; Nagurney, 2014), we focus on strategic planning of energy production infrastructure, which means the physical configuration of the supply chain network is not fixed. In addition, we explicitly incorporate the transmission network between supplies and demands, unlike the above mentioned non-spatial stochastic oligopolistic energy models and most existing power supply chain models, which are built on simplified transshipment network (supply nodes and demand nodes are connected via direct links rather than a general transmission network). This treatment allows us to better capture the network effects, but also requires innovative computational methods to overcome the increases model complexity.

The remaining part of this paper will be organized as follows. In Section 2, we first introduce a general stochastic modeling framework, which is an extension of the classic single-player two-stage stochastic programming to multi-decision-maker cases. We then describe the behavior of each party involved in the power grid, and give specific assumptions and formulation of the proposed model. In Section 3, we demonstrate how the original energy problem may be reformulated and converted to multiple user-equilibrium traffic network assignment problems. In Section 4, we present numerical results and draw planning and policy implications. The last section concludes the paper with insights, discussions, and future extensions.

2. MATHEMATICAL MODEL AND ANALYSES

2.1. A stochastic multi-agent optimization modeling framework

The research question is stated as: How should renewable energy investors strategically plan their production infrastructure (where and at what capacities to build their production facilities), to ensure long-term economic benefit while integrating renewable energies with the existing power grid?

Even though our emphasis is on the strategic planning of production infrastructure, the cost-effectiveness of a planning decision depends on how the system is likely to be operated afterwards. To model the planning and operational stages in an integrated framework, one should recognize the very distinguishable natures of the two types of decisions against uncertainty, which may be related to demand, supply, and technology. At this point, let us use a

general notation ξ to represent the uncertain vector. We assume ξ follows a discrete probability distribution, described by a set of discrete scenarios and associated probabilities. Planning decisions, such as infrastructure setup, are usually made before future uncertainty is revealed and are difficult to readjust once implemented. On the other hand, operational decisions such as electricity production and dispatching quantities can be adjusted based on the actual realization of uncertain parameters (for example, the actual demand or a more accurate hour-ahead demand forecast). This feature fits well in a stochastic programming framework (Louveaux, 1986; Birge and Louveaux, 2011), which recognizes the non-anticipativity of planning decisions while allowing recourse for operational decisions.

The classic two-stage stochastic program for a single decision maker, in the simplest form, may be presented as follows (Birge and Louveaux, 2011):

$$\underset{\mathbf{x}}{\text{minimize}} \quad f(\mathbf{x}) + \mathbb{E}_\xi [Q(\mathbf{x}, \xi)] \quad (1a)$$

$$\text{subject to} \quad \mathbf{x} \in F \quad (1b)$$

$$Q(\mathbf{x}, \xi) = \inf_{\mathbf{y}} \{g(\mathbf{x}, \mathbf{y}, \xi) | \mathbf{y} \in G(\mathbf{x}, \xi)\}, \quad (1c)$$

where \mathbf{x} represents the planning-stage decision, and \mathbf{y} the operational decision, which depends on the choice of planning decision and the actual realization of the uncertain parameters ξ . The objective is to minimize the first-stage planning cost, $f(\mathbf{x})$, plus the expected value of the second-stage operational cost, $Q(\mathbf{x}, \xi)$, subject to the feasibility constraints of \mathbf{x} and \mathbf{y} .

In our problem, each decision entity makes her own decision, but needs to simultaneously account for other decision entities' behaviors given the interdependence among them. For example, too much electricity generation at a local point may increase transmission congestion, which could affect all parties in the power system. Using a two-player problem as an example, the above formulation (1a ~ 1c) may be extended to the following:

$$(\mathbf{x}_1, \mathbf{y}_1) = \arg \min_{\mathbf{x}_1, \mathbf{y}_1} \{f_1(\mathbf{x}_1, \mathbf{x}_2) + \mathbb{E}_\xi [g_1(\mathbf{x}_1, \mathbf{x}_2, \mathbf{y}_1, \mathbf{y}_2, \xi)]\}$$

$$(\mathbf{x}_2, \mathbf{y}_2) = \arg \min_{\mathbf{x}_2, \mathbf{y}_2} \{f_2(\mathbf{x}_1, \mathbf{x}_2) + \mathbb{E}_\xi [g_2(\mathbf{x}_1, \mathbf{x}_2, \mathbf{y}_1, \mathbf{y}_2, \xi)]\}$$

$$\text{s.t.} \quad (\mathbf{x}_1, \mathbf{x}_2) \in F \quad \text{and} \quad (\mathbf{y}_1, \mathbf{y}_2) \in G(\mathbf{x}_1, \mathbf{x}_2, \xi),$$

where \mathbf{x}_i and $\mathbf{y}_i(\xi)$ represent the planning decision and the operational decision of player i ($i = 1, 2$), respectively; and f_i and g_i are the first-stage and second-stage costs of player i , respectively. Each player aims at minimizing her own total planning and operating cost in an average sense. Note that $\mathbf{y}_i(\xi)$ is ξ -specific, but for brevity, we write it as \mathbf{y}_i . Also, for

95 generality, we denote f_i as a function of the planning decisions of both players, which may be simplified to $f_i(\mathbf{x}_i)$ in many cases. This problem may be classified as a stochastic multi-agent optimization problem, for which new research endeavors are being pursued to better understand the analytical and numerical properties (Jofre and Wets, 2014).

2.2. Detailed Formulation for Each Decision Entity

100 The electricity market in the US is generally considered as an oligopoly market, even though the levels of market competitiveness vary by regions (Bushnell et al., 2007). As pointed out in a review paper on power generation planning (Kagiannas et al., 2004), as the electricity market has undergone from monopoly to competition, studies dealing with both investment and operations in an oligopolistic electricity market are critically needed. Depending on the decision variables and anticipation of rivals' reaction (Day et al., 2002), an US electricity market is often modeled
105 based on one of the following:

- Cournot competition (Cournot and Fisher, 1897), which assumes each generator submits a supply quantity instead of a pair of bidding price and supply capacity. The advantage of Cournot models is that they allow for more complex market settings. If one is interested
110 in transmission network constraints or some detail generation characteristics, Cournot models are preferred (Willems et al., 2009; Hu et al., 2004). However, Cournot model is known to be sensitive to demand parameters.
- Supply Function Equilibrium (SFE) Models are also widely used in electricity market. SFE models assume firms can only submit one bid (i.e. available production quantity as a
115 function of price) for all demand realization, regardless of time and demand shock. They were developed to address varying demand conditions (Day et al., 2002).

In this study we adopt the concept of Cournot competition and compute the equilibrium nodal electricity price given generators' access locations and cost functions. These equilibrium prices will be used by each firm to estimate its total revenue. Conceptually, choice between
120 Cournot and SFE models depends on whether companies are bidding without price dependency or bidding without market state dependency (Willems et al., 2009). Numerically, Cournot competition is usually easier than SFE models due to issues of multiple equilibrium and unstable solutions brought by the latter. It can be shown that if firms know exactly the market realization, SFE and Cournot models yield the same solution (Willems et al., 2009).

125 *2.2.1. Modeling the decision of electricity generation companies*

A new energy generator that is entering the system has two types of decisions to make. During the planning stage, it decides where and at what capacity to invest its production facilities. At the operational stage, it chooses its best production or pricing strategy. This generator makes all these decisions to maximize the expected total profit while taking into
 130 account the decisions of other entities in the system. For each generation Firm $\forall i \in I$:

$$\text{maximize}_{g_i^j(\boldsymbol{\xi}), c_i^j} \quad - \sum_{k \in K} \sum_{j \in J_k} \phi_c(c_i^j) + \mathbb{E}_{\boldsymbol{\xi}} \left\{ \sum_{k \in K} \sum_{j \in J_k} \left[\rho_k(\boldsymbol{\xi}) g_i^j(\boldsymbol{\xi}) - \phi_g(g_i^j(\boldsymbol{\xi}), \boldsymbol{\xi}) \right] \right\} \quad (2a)$$

$$\text{subject to} \quad g_i^j(\boldsymbol{\xi}) - \alpha^j(\boldsymbol{\xi}) c_i^j \leq 0, \quad \forall j \in J_k, k \in K, \boldsymbol{\xi} \in \Xi; \quad (2b)$$

$$g_i^j(\boldsymbol{\xi}) \geq 0, \quad \forall j \in J_k, k \in K, \boldsymbol{\xi} \in \Xi; \quad (2c)$$

$$c_i^j \geq 0, \quad \forall j \in J_k, k \in K. \quad (2d)$$

where:

J_k : set of wind farm locations connecting to access point k , indexed by j ;

K : set of access points, indexed by k ;

I : set of companies, indexed by i ;

135 c_i^j : capacity allocated at location j by firm i ;

g_i^j : production quantity by Firm i at location j ;

ρ_k : ISO's electricity purchasing price at each accessing point k ;

α^j : renewable energy capacity discount factor at location j . This parameter is usually weather dependent. For example in wind energy case, a less windy day would correspond
 140 to a smaller value of α^j ;

$\phi_c(\cdot)$: total capital cost function with respect to facility capacity;

$\phi_g(\cdot)$: total production cost function with respect to generation quantity and scenario;

$\boldsymbol{\xi}$: vector of uncertain parameters, whose support is denoted by Ξ .

Note that throughout the entire paper, we denote vectors in lowercase bold font. The objective
 145 function (2a) maximizes the total profit of each firm, which is the total revenue minus the total

capital and production costs. The decision variables include the capacity and generation amount at each potential production location. We assume that electricity can be sold at a uniform price at each access point (Locational Marginal Price), so the total revenue is calculated by $\sum_{k \in K} \sum_{j \in J_k} \rho_k g_i^j$. Constraint (2b) ensures that the total electricity generated at a production facility does not exceed its production capacity. The rest are non-negative restrictions.

2.2.2. Modeling the decision of Independent System Operator (ISO)

The ISO decides the wholesale price and transmission flow of each transmission line to balance electricity supply and demand in the network instantaneously. Considering the non-profit nature of ISO, we set its goal as to maximize total consumer surplus. Since ISO's decisions are operational, these can be adjusted based on the actual realization of future uncertainty, i.e., scenario dependent. To capture congestion effect of transmission lines, we assume that transmission cost is a monotone increasing function of the transmuted flow quantity, which is a similar treatment as in (Hearn and Yildirim, 2002). Denote the transmission network by $\mathcal{G} = (\mathcal{N}, \mathcal{V})$, where \mathcal{N} is the set of nodes (indexed by n) and \mathcal{V} is the set of links (indexed by a). Electricity from a supply (origin) node to a demand (destination) node is modeled as an O-D flow. ISO's decision, in a given scenario, is formulated as:

$$\begin{aligned} & \underset{\mathbf{x}, \mathbf{t}}{\text{minimize}} && \phi_t(\mathbf{v})^T \mathbf{v} + \boldsymbol{\rho}^{*T} \mathbf{g} - \sum_{k \in K} \int_0^{d_k} w_k(s) ds \end{aligned} \quad (3a)$$

$$\text{subject to} \quad \mathbf{v} = \sum_{q \in Q} \mathbf{x}^q, \quad (3b)$$

$$A\mathbf{x}^q = t^q E^q, \quad \forall q \in Q, \quad (3c)$$

$$\sum_{q \in Q} t^q E^{q+} = \mathbf{g}, \quad (3d)$$

$$\sum_{q \in Q} t^q E^{q-} = \mathbf{d}, \quad (3e)$$

$$\mathbf{x}^q \geq 0, \quad \forall q \in Q, \quad (3f)$$

$$t^q \geq 0, \quad \forall q \in Q. \quad (3g)$$

where:

\mathbf{v} : aggregated link flow vector. Each element corresponds to a link;

\mathbf{t} : O-D flow vector. Each element corresponds to an O-D pair;

$\phi_t(\cdot)$: transmission cost function, which depends on link flow;

- $\boldsymbol{\rho}^*$: equilibrium wholesale price vector. Each element corresponds to a node;
- \mathbf{g} : electricity supply vector. The j^{th} element corresponds to the total energy supplied by all companies at node j , that is $g_j = \sum_{i \in I} g_i^j$;
- \mathbf{x}^q : link flow vector associated with OD pair q . Each element corresponds to a link ;
- 160 \mathbf{d} : electricity demand vector. Each element corresponds to a node;
- d_k : total electricity demand at node k ;
- $w_k(\cdot)$: inverse demand function at node k ;
- A : node-link incidence matrix, whose rows correspond to nodes and columns correspond to links, with +1 indicates the starting node of a link and -1 the ending node.
- 165 Q : set of O-D pairs, indexed by q ;
- t^q : O-D flow associate with O-D pair q ;
- E^q : O-D incidence vector of O-D pair q with +1 at the origin and -1 at the destination;
- E^{q+} : “O” incidence vector of O-D pair q with +1 at the origin;
- E^{q-} : “D” incidence vector of O-D pair q with +1 at the destination.

170 The objective function (3a) maximizes (minimizes the negative value of) the total consumer surplus. The first term in function (3a) is the total transmission cost, the second term is the total whole-sale price for all the electricity consumed in the system. The summation of the first two terms is the total price passed onto consumers. The third term is the willingness to pay by all consumers. Constraint (3b) defines the aggregate link flow vector as the sum of all O-D flow
 175 vectors. Constraints (3c ~ 3e) ensure the flow conservation at each node, including the supply and demand nodes. The rest constraints set non-negative restrictions on flow and demand. We shall point out that the market clearing conditions adopted in several studies, such as (Nagurney, 2006), are implied by the ISO formulation, which becomes clear in Section 2.4. Note that this model, different from the typical DC models used for short-term transmission network operation,
 180 incorporates elastic demand, which reflects long-term effect of market equilibrium.

Directly solving the above stochastic multi-agent optimization model can be numerically challenging. In Section 2.3, we show how the stochastic problem can be reduced to simpler problems through scenario decomposition. In Section 2.4, we convert each scenario problem, by

using variational inequalities, to a traffic user equilibrium problem, for which efficient solution
 185 algorithms have been developed in the transportation literature.

2.3. Scenario Decomposition

There is a rich literature on scenario decomposition for solving large-scale stochastic programming problems via augmented Lagrangian method (Rockafellar, 1976). Let us first introduce an important concept, nonanticipativity (Rockafellar and Wets, 1991), which states that a reasonable policy should not require different actions relative to different scenarios if the scenarios are not distinguishable at the time when the actions are taken. Let S be a discrete set of possible scenarios for ξ and $s(s \in S)$ denote an individual scenario with probability p^s . One may consider solving each scenario-dependent problem and denote its solution as \mathbf{x}^s for each s . However, these solutions cannot be directly implemented, because at the time when an investment decision is made, one does not know yet which scenario is going to happen. In order to consolidate the s -dependent solutions to an *implementable* solution, we must impose the following nonanticipativity condition:

$$\mathbf{x}^s = \mathbf{x}^{s'}, \forall s \in S, s' \in S, s \neq s' \quad (4)$$

or equivalently

$$\mathbf{x}^s - \mathbf{z} = 0, \forall s \in S \quad (5)$$

where \mathbf{z} is a vector of free variables.

Through introducing an augmented Lagrangian function that adds a penalty of violating the nonanticipativity condition to the original objective function, Rockafellar and Wets (1991)
 190 developed a scenario-decomposition method, the progressive hedging (PH) method, for classic two-stage stochastic programming problems involving a single decision-maker. In this work, we extend the idea of scenario decomposition to multiple decision-maker cases.

Let \mathbf{x}_i^s and \mathbf{y}_i^s be the planning decision and the operational decision of player $i(i \in I)$ in scenario $s(s \in S)$, respectively. The stochastic multi-agent optimization problem can be reformulated as:

$$\begin{aligned} (\mathbf{x}_i^s, \mathbf{y}_i^s) &= \arg \min_{\mathbf{x}_i^s, \mathbf{y}_i^s} \{E [f_i(\mathbf{x}_i^s, \mathbf{x}_{-i}^s) + g_i(\mathbf{x}_i^s, \mathbf{x}_{-i}^s, \mathbf{y}_i^s, \mathbf{y}_{-i}^s, \xi)]\}, \\ \text{s.t.} \quad & (\mathbf{x}_i^s, \mathbf{x}_{-i}^s) \in F, \quad \mathbf{x}_i^s = \mathbf{z}_i, \quad \text{and} \quad (\mathbf{y}_i^s, \mathbf{y}_{-i}^s) \in G(\mathbf{x}_i^s, \mathbf{x}_{-i}^s, \xi), \\ & \forall i \in I, s \in S \end{aligned}$$

For the i^{th} player, define

$$\mathcal{L}_i(\mathbf{x}, \mathbf{y}, \mathbf{z}, \boldsymbol{\omega}) = \sum_{s \in S} p^s \left[f_i^s(\mathbf{x}^s) + g_i^s(\mathbf{x}^s, \mathbf{y}^s) + \boldsymbol{\omega}_i^{sT} (\mathbf{x}_i^s - \mathbf{z}_i) + \frac{1}{2} \gamma \|\mathbf{x}_i^s - \mathbf{z}_i\|^2 \right] \quad (6)$$

as the augmented Lagrangian, where $\boldsymbol{\omega}_i^s$ is the dual vector associated with the nonanticipativity constraints (5) and $\gamma > 0$ is a penalty parameter. Therefore, the augmented Lagrangian integrates the nonanticipativity constraints with the original objective function. The stochastic problem for player i becomes

$$\text{minimize } \mathcal{L}_i(\mathbf{x}, \mathbf{y}, \mathbf{z}, \boldsymbol{\omega}) \quad \text{over all feasible } \mathbf{x}_i^s \text{ and } \mathbf{y}_i^s. \quad (7)$$

Due to the nonseparable penalty term $1/2\gamma\|\mathbf{x}_i^s - \mathbf{z}_i\|^2$ in (6), the problem cannot be decomposed directly. The PH method achieves decomposition by alternately fixing the scenario solutions $(\mathbf{x}_i^s, \mathbf{y}_i^s)$ and the implementable solution \mathbf{z}_i in (7). One may refer to (Rockafellar and Wets, 1991) for details of the PH method as a scenario-decomposition method for classic two-stage stochastic programming problems.

2.4. Analyzing each scenario-dependent problem

Once the large-scale stochastic problem is decomposed, we need to iteratively solve many scenario-dependent deterministic problems. Each scenario-dependent problem itself is a multi-agent optimization problem, which is still computationally challenging. Next, we will show that, through creation of a virtual network and reformulation, we can convert the problem of interest to a traffic equilibrium problem, which allows us to exploit efficient algorithms developed by the transportation network science community. Of course, both multi-agent optimization and traffic equilibrium problems can be expressed using variational inequalities (VI). In some sense, it is not surprising that the two problems can be converted to each other, even though the equivalence is not apparent at first. For numerical implementation, one could directly rely on general purpose solvers designed for VI problems. On the other hand, there is an advantage in exploiting special problem structure, such as many efficient algorithms specifically developed for traffic equilibrium problems.

Let us first convert each player's optimization to a VI. Note that all the functions and variables are deterministic in each scenario dependent problem, therefore we do not carry the notation $\boldsymbol{\xi}$ in the following discussion. Assuming objective function (2) is concave and continu-

ously differentiable, the model can be rewritten as the following VI¹:

$$\begin{aligned}
& \sum_{k \in K} \sum_{j \in J_k} \left\{ - \left[\rho_k^* + \sum_{k' \in K} \left(\frac{\partial \rho_{k'}}{\partial g_i^j} \Big|_{\mathbf{g}=\mathbf{g}^*} \sum_{j \in J_{k'}} g_i^{j*} \right) - \frac{\partial \phi_g}{\partial g_i^j} \Big|_{g_i^j=g_i^{j*}} - \lambda_c^{ij*} \right] (g_i^j - g_i^{j*}) \right. \\
& \quad \left. - \left[- \frac{\partial \phi_c}{\partial c_i^j} \Big|_{c_i^j=c_i^{j*}} + \alpha^j \lambda_c^{ij*} \right] (c_i^j - c_i^{j*}) + (-g_i^{j*} + \alpha^j c_i^{j*}) (\lambda_c^{ij} - \lambda_c^{ij*}) \right. \\
& \quad \left. \right\} \geq 0, \forall (\mathbf{g}_i, \mathbf{c}_i, \boldsymbol{\lambda}_i) \in \mathcal{X}_i^1 \\
& \quad \mathcal{X}_i^1 \equiv \left\{ (\mathbf{g}_i, \mathbf{c}_i, \boldsymbol{\lambda}_i) \in R_+^{3l_i} \mid (2b) \text{ is satisfied} \right\}
\end{aligned} \tag{8}$$

215 where:

λ_c^{ij} : dual variable of capacity constraint of firm i on location j ;

\mathbf{g}_i : vector that concatenates g_i^j variables;

\mathbf{c}_i : vector that concatenates c_i^j variables;

$\boldsymbol{\lambda}_i$: vector that concatenates λ_c^{ij} variables;

220 l_i : number of optional locations for each companies i ;

\mathcal{X}_i^1 : feasible set of firm i 's decision.

Similarly, the ISO's problem can be expressed using VI as follows:

$$\begin{aligned}
& \sum_{q \in Q} [\phi_t(\mathbf{v}^*) + \nabla \phi_t(\mathbf{v}^*) \mathbf{v}^* - A^T \lambda^{q*}]^T (\mathbf{x}^q - \mathbf{x}^{q*}) \\
& + \sum_{q \in Q} \left[E^{qT} \lambda^{q*} + \boldsymbol{\rho}^{*T} E^{q+} - w(\mathbf{d}^{*T}) E^{q-} \right] (t^q - t^{q*}) \geq 0, \forall \mathbf{x}^q, \mathbf{t}^q \in \mathcal{X}^2
\end{aligned} \tag{9}$$

$$\mathcal{X}^2 \equiv \{(\mathbf{x}, \mathbf{t}) \mid (3b) \sim (3g) \text{ is satisfied}\}$$

where:

$\nabla \phi_t(\cdot)$: Jacobian matrix of link cost function;

¹Note that since the wholesale prices depend on the production quantities, chain rule of differentiation should be used while taking derivatives to arrive at the VI.

225 λ^q : dual vector associated with constraint (3c) of O-D pair q . Each row corresponds to a link;

\mathcal{X}^2 : feasible set of ISO decision.

Note that the market clearing conditions (Nagurney, 2006) are implied by the ISO formulation: The second term in Equation (9) means that if the demand of OD pair q , t^q , is zero, then
 230 the wholesale price plus the transmission cost can be larger than the consumer willingness to pay; otherwise, the wholesome price plus the transmission cost must be equal to the consumer willingness to pay. In addition, note that in constraint (3c), ISO is required to balance demand and supply at all time, so the dual variable associated with this equality constraint is a free variable.

235 As stated before, the decisions of all participants in this system are interdependent and should be modeled simultaneously as a whole system. We state the system equilibrium more formally by the following definition.

Definition 1. (*Power System Equilibrium*). The equilibrium state of a power system is that all generators achieve their own optimality (cf. (8)) and ISO achieves its optimality (cf. (9)).

240 We claim the following Lemma, which provides the equivalent condition of the power system equilibrium conditions.

Lemma 1. (*Variational Inequality Condition for the Power System Equilibrium*). The equilibrium conditions governing the power system equilibrium are equivalent to finding solutions satisfying the following variational inequality (10):

$$\begin{aligned}
 & \sum_{k \in K} \sum_{j \in J_k} \left[- \sum_{k' \in K} \left(\frac{\partial \rho_{k'}}{\partial g_i^j} \Big|_{\mathbf{g}=\mathbf{g}^*} \sum_{j \in J_{k'}} g_i^{j*} \right) + \frac{\partial \phi_g}{\partial g_i^j} \Big|_{g_i^j=g_i^{j*}} + \frac{\partial \phi_c}{\partial c_i^j} \Big|_{c_i^j=c_i^{j*}} \right] (g_i^j - g_i^{j*}) \\
 & + [\phi_t(\mathbf{v}^*) + \nabla \phi_t(\mathbf{v}^*) \mathbf{v}^*]^T (\mathbf{v} - \mathbf{v}^*) - w(\mathbf{d}^{*T}) (\mathbf{d} - \mathbf{d}^*) \\
 & + \sum_{k \in K} \sum_{j \in J_k} \left\{ \frac{\partial \phi_c}{\partial c_i^j} \Big|_{c_i^j=c_i^{j*}} \left[(c_i^j - g_i^j) - (c_i^{j*} - g_i^{j*}) \right] \right. \\
 & \left. - \lambda_c^{ij*} \left[(c_i^j - g_i^j) - (c_i^{j*} - g_i^{j*}) \right] + (c_i^{j*} - g_i^{j*} - 0) (\lambda_c^{ij} - \lambda_c^{ij*}) \right\} \geq 0 \\
 & \forall (\mathbf{g}_i, \mathbf{c}_i, \boldsymbol{\lambda}_i) \in \mathcal{X}_i^1, \forall i, \forall (\mathbf{x}, \mathbf{t}) \in \mathcal{X}^2
 \end{aligned} \tag{10}$$

PROOF. Combining VI (2) and (4), we have the following terms cancelled out:

1. $\sum_{q \in Q} [-A^T \gamma^{q*}]^T (\mathbf{x}^q - \mathbf{x}^{q*})$ and $\sum_{q \in Q} E^{qT} \gamma^{q*} (t^q - t^{q*})$

$$2. \sum_{k \in K} \sum_{j \in J_k} \rho_k^* (g_i^j - g_i^{j*}) \text{ and } \sum_{q \in Q} \vec{p}^{*T} E^{q+} (t^q - t^{q*})$$

245 The first cancellation is derived by Constraint (3c), and the second cancellation is derived by Constraint (3d). Then, add $-\frac{\partial \phi_c}{\partial c_i^j} \Big|_{c_i^j=c_i^{j*}} (g_i^j - g_i^{j*})$ and subtract $-\frac{\partial \phi_c}{\partial c_i^j} \Big|_{c_i^j=c_i^{j*}} (g_i^j - g_i^{j*})$, and reorganize the formulation in terms of variables \mathbf{g} and $\mathbf{c} - \mathbf{g}$. Finally, after the use of Constraint (3b) and (3e) to substitute (\mathbf{x}, \mathbf{t}) with (\mathbf{v}, \mathbf{d}) , VI (10) is derived. \square

Next we will show the VI problem in (10) is equivalent to a transportation network user equilibrium problem. Let us use a simple case illustrated in Figure 1 as an example to explain the construction of a virtual network corresponding to a traffic network equilibrium problem. In Figure 1, a virtual node C denotes an investment firm; F denotes a potential renewable energy farm location or an existing generator. The link flow from a node C to a node F means the capacity that firm C invests at location F. For an existing generator, link flow of C-F is set to be the existing generation capacity. Each node P or U corresponds to a firm. The flows on link F-P and link F-U denote the electricity production quantity and the unused capacity of that firm at location F, respectively. Virtual node I is created to denote electricity that shares the same transmission infrastructure to access the existing power grid. Physical node A denotes an access point or a demand node in the power grid. In general, there are multiple access points and demand nodes in a power network. The flow on link P-I denotes the total electricity production of each firm, and the flow on link I-A or P-A denotes the transmission quantity between the corresponding locations.

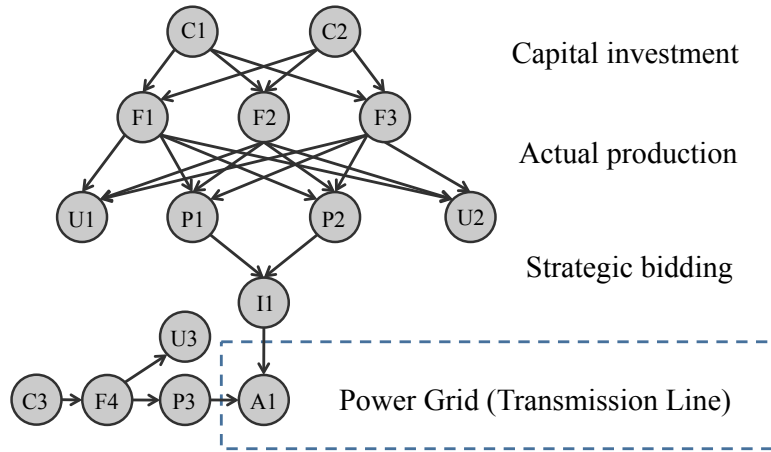

Figure 1: A Network Structure of the Problem

Theorem 2. (Virtual Network Equivalence) The VI (10) is identical with the VI governing

transportation user equilibrium of the virtual network shown in Figure 1 if link costs and demand
 265 market are defined in the following manner:

- For the links within “Capital investment” layer in Figure 1 (i.e. from Node C to Node F),
 the link cost is set to be the marginal capacity cost, i.e. $\partial\phi_c(c_i^j)/\partial c_i^j$. In case of existing
 generators, the cost attached to this link is set to be zero.
- For links connecting Node F and Node P, the link cost is marginal production cost, i.e.
 270 $\partial\phi_g(g_i^j)/\partial g_i^j$.
- For links connecting Node F and Node U, the link cost represents the cost of shutting off
 unused generation capacity. In case such cost is negligible, it can be set to zero.
- For links connecting Node P and Node I, we interpret the link cost as strategic escalating of
 electricity price of each generator, which is set to $-\sum_{k' \in K} \left(\frac{\partial \rho_{k'}}{\partial g_i^j}(\mathbf{g}) \sum_{j \in J_{k'}} g_i^j \right)$. Because
 275 we assume oligopoly competition, rather than perfect competition in the electricity supply
 industry, each firm will try to produce electricity at a level where the wholesale price equals
 to the marginal cost plus this term so that the profit is maximized.
- For links within the power grid, a marginal transmission cost is imposed by the ISO, i.e.
 $\phi_t(v) + \nabla\phi_t(v)v$.
- The demand functions of the nodes within the power grid are assumed to be given and
 280 depend on the retail price only, while the demand function of Node U is assigned zero
 despite of the value of capacity shadow price.

Before we give the proof of Theorem 2, we introduce the following Theorem provided in
 (Nagurney, 2006):

Theorem 3. *A travel link flow pattern and associated travel demand and disutility pattern is a
 traffic network equilibrium if and only if the variational inequality holds: determine $(f^*, d^*, \lambda^*) \in$
 \mathcal{H}^3 satisfying:*

$$\begin{aligned} & \sum_{a \in L} \phi_a(f^*) \times (f_a - f_a^*) - \sum_{n \in N} \lambda_n^* \times (d_n - d_n^*) \\ & + \sum_{n \in N} [d_n^* - d_n(\lambda^*)] \times [\lambda_n - \lambda_n^*] \geq 0, \forall (\mathbf{f}, \mathbf{d}, \boldsymbol{\lambda}) \in \mathcal{H}^3 \end{aligned} \quad (11)$$

$$\mathcal{H}^3 \equiv \left\{ (\mathbf{f}, \mathbf{d}, \boldsymbol{\lambda}) \in R_+^{|L|+2|N|} \mid \text{there exist an } \boldsymbol{\chi} \text{ satisfying (12) and (13)} \right\}$$

$$f_a = \sum_{p \in P} \chi_p \delta_{ap}, \forall a \in L \quad (12)$$

$$d_n = \sum_{p \in P_n} \chi_p, \forall n \in N \quad (13)$$

where:

N : demand node set of virtue transportation network (indexed by n);

L : link set of virtue transportation network (indexed by a);

P : path set of virtue transportation network (indexed by p);

290 δ_{ap} : binary indicator, $\delta_{ap} = 1$ if link a is contained in path p , and $\delta_{ap} = 0$ otherwise;

$\phi_a(\cdot)$: link cost function of link a with respect to link flow;

f_a : link flow of link a ;

d_n : demand at demand node n ;

$d_n(\cdot)$: demand function at demand node n with respect to travel disutility;

295 λ_n : travel disutility at demand node n ;

χ_p : path flow of path p ;

Notice that in Theorem 3, travel disutility is restricted to non-negative value, which is not applicable in power market, where price can become negative if necessary (e.g. the ISO may pay consumers to use electricity if supply exceeds demand and shutting down production facilities is too costly). So we propose the following Corollary to account for this situation.

Corollary 4. (*Unrestricted Locational Price*). *In a virtual transportation network where consumer can gain time (instead of spend time) to travel, a travel link flow, travel demand and disutility pattern (negative means utility) is a traffic network equilibrium if and only if it satisfies the following VI: determine $(f^*, d^*, \lambda^*) \in \mathcal{K}^4$ satisfying:*

$$\sum_{a \in L} \phi_a(f^*) \times (f_a - f_a^*) - \sum_{n \in N} \lambda_n^* \times (d_n - d_n^*) \geq 0, \forall (\mathbf{f}, \mathbf{d}, \boldsymbol{\lambda}) \in \mathcal{K}^3 \quad (14)$$

$$\mathcal{K}^3 \equiv \left\{ (\mathbf{f}, \mathbf{d}, \boldsymbol{\lambda}) \in R_+^{|L|+|N|} \times R^{|N|} \mid \text{there exist an } \boldsymbol{\chi} \text{ satisfying (12) and (13)} \right\}$$

Note that since the dual vector λ does not have sign restriction, its corresponding optimality condition is simply the original constraints associated with it, i.e. (3c), which can be equivalently expressed by (12) and (13).

305 Now we propose the proof for Theorem 2.

PROOF (THEOREM 2). There are two types of demand nodes in the virtual transportation network: the nodes within transmission network, denoted by ‘‘A’’; and the virtual nodes representing unused capacity, denoted by ‘‘U’’. A-nodes do not have non-negativity constraint on price, so VI (14) is applied for these nodes (Corollary 4), while VI (11) is applied for U-nodes 310 (Theorem 3). After algebraic simplification, the VI governing the virtual transportation network is identical with VI (10). \square

Note that in each iteration of the PH method, the objective function is updated by adding a Lagrange multiplier and a penalty term, i.e. $\omega_i^{sT}(\mathbf{x}_i^s - \mathbf{z}_i) + \frac{1}{2}\gamma\|\mathbf{x}_i^s - \mathbf{z}_i\|^2$, which is a function of the planning decision variable. Therefore, the corresponding VI that needs to be solved during each iteration of the PH procedure should be modified as:

$$\begin{aligned} & \sum_{k \in K} \sum_{j \in J_k} \left[- \sum_{k' \in K} \left(\frac{\partial \rho_{k'}}{\partial g_i^j} \Big|_{\mathbf{g}=\mathbf{g}^*} \sum_{j \in J_{k'}} g_i^{j*} \right) + \frac{\partial \phi_g}{\partial g_i^j} \Big|_{g_i^j=g_i^{j*}} + \frac{\partial \phi_c}{\partial c_i^j} \Big|_{c_i^j=c_i^{j*}} + \omega_{ij}^{s*} \right. \\ & \left. + \gamma \left(c_i^{js*} - \bar{c}_i^{js*} \right) \right] \left(g_i^j - g_i^{j*} \right) + [\phi_t(\mathbf{v}^*) + \nabla \phi_t(\mathbf{v}^*) \mathbf{v}^*]^T (\mathbf{v} - \mathbf{v}^*) - w(\mathbf{d}^{*T})(\mathbf{d} - \mathbf{d}^*) \\ & + \sum_{k \in K} \sum_{j \in J_k} \left\{ \left[\frac{\partial \phi_c}{\partial c_i^j} \Big|_{c_i^j=c_i^{j*}} + \omega_{ij}^{s*} + \gamma \left(c_i^{js*} - \bar{c}_i^{js*} \right) \right] \left[\left(c_i^j - g_i^j \right) - \left(c_i^{j*} - g_i^{j*} \right) \right] \right. \\ & \left. - \lambda_c^{ij*} \left[\left(c_i^j - g_i^j \right) - \left(c_i^{j*} - g_i^{j*} \right) \right] + \left(c_i^{j*} - g_i^{j*} - 0 \right) \left(\lambda_c^{ij} - \lambda_c^{ij*} \right) \right\} \geq 0 \end{aligned} \quad (15)$$

$$\forall (\mathbf{g}_i, \mathbf{c}_i, \boldsymbol{\lambda}_i) \in \mathcal{K}_i^1, \forall i, \forall (\mathbf{x}, \mathbf{t}) \in \mathcal{K}^2$$

The additional terms involving $\omega_{ij}^{s*} + \gamma \left(c_i^{js*} - \bar{c}_i^{js*} \right)$ is attributed to the nonanticipativity condition. Therefore the link cost associated with C-F should be modified from $\partial \phi_c(c_i^j)/\partial c_i^j$ (see Theorem 2) to:

$$\text{modified C-F link cost} = \partial \phi_c(c_i^j)/\partial c_i^j + \omega_{ij}^s + \gamma \left(c_i^{js*} - \bar{c}_i^{js} \right) \quad (16)$$

Based on the same network structure shown in Figure 1, we now have the PH-transportation network solution procedure for the stochastic problem as shown in Algorithm 1. Following this decomposition procedure, the original stochastic energy supply chain problem is converted

315 to many scenario-dependent deterministic traffic network equilibrium problems, which can be
solved efficiently by Frank-Wolf algorithm (LeBlanc, 1975), which is implemented in this study,
or by other recent methods summarized in (Bar-Gera, 2010).

We shall note that in general the VI defined in (15) may have multiple solutions. For the
numerical implementation reported herein, we consider only the single-solution case. Alterna-
320 tively, one may consider a min-max formulation to seek the best investment decision in the
equilibrium condition that returns the worst-case performance.

Algorithm 1 PH-Transportation Network Solution Algorithm

Step 1: Initialization

for each s in S **do**

 update link cost according to Theorem 2

 call Traffic Assignment Algorithm ▷ Such as the algorithm in (LeBlanc, 1975)

$(\mathbf{c}^{(0)}, \mathbf{g}^{(0)}, \boldsymbol{\rho}^{(0)}, \boldsymbol{\lambda}_c^{(0)}) \leftarrow$ call Recover Decision Function ▷ See Appendix Subroutine

end for

$$\mathbf{z}^{(0)} \leftarrow \sum_{s \in S} p^s \mathbf{c}_s^{(0)}$$

$$\boldsymbol{\omega}_s^{(0)} \leftarrow \gamma(\mathbf{c}_s^{(0)} - \mathbf{z}^{(0)}), \quad \forall s \in S$$

Step 2: PH-iteration

$\tau = 0$

▷ Initialize PH iteration index

while $\epsilon \geq 10^{-4}$ **do**

for each s in S **do**

$\tau \leftarrow \tau + 1$

 update link cost according to Theorem 2 and (16).

 call Traffic Assignment Function ▷ Such as the algorithms in (LeBlanc, 1975)

$(\mathbf{c}^{(\tau)}, \mathbf{g}^{(\tau)}, \boldsymbol{\rho}^{(\tau)}, \boldsymbol{\lambda}_c^{(\tau)}) \leftarrow$ call Recover Decision Function ▷ See Appendix Subroutine

$$\mathbf{z}^{(\tau)} \leftarrow \sum_{s \in S} p^s \mathbf{c}_s^{(\tau)}$$

$$\boldsymbol{\omega}_s^{(\tau)} \leftarrow \boldsymbol{\omega}_s^{(\tau-1)} + \gamma(\mathbf{c}_s^{(\tau)} - \mathbf{z}^{(\tau)}), \quad \forall s \in S$$

end for

$$\epsilon \leftarrow \sum_{s \in S} \|\mathbf{c}_s^\tau - \mathbf{z}^\tau\| + \sum_{s \in S} \|\mathbf{c}_s^\tau - \mathbf{c}_s^{\tau-1}\|$$

end while

return $(\mathbf{c}, \mathbf{g}, \boldsymbol{\rho}, \boldsymbol{\lambda}_c)$

3. NUMERICAL EXAMPLES

3.1. A simple example for illustration and solution validation

Example 1 is constructed to illustrate how the energy problem may be decomposed and converted to traffic network equilibrium problems. The example is intentionally set to be symmetric so that a benchmark solution can be easily obtained analytically, which then is used to validate the proposed solution procedure. This example includes two energy investment companies, one wind farm location option, and one electricity demand market. Two scenarios with equal probability are considered. Transmission cost is set to be zero and transmission capacity unlimited. The specifics of cost and demand functions are given in Table 1.

Table 1: Parameter Setting in Example 1

Scenario	Capital Cost Function		Generation Cost Function		Demand Function
	Firm 1	Firm 2	Firm 1	Firm 2	
1	$10 \times c_1$	$10 \times c_2$	$(g_1^{s_1})^2 + 30 \times g_1^{s_1}$	$(g_2^{s_1})^2 + 30 \times g_2^{s_1}$	$\rho = -D + 100$
2	$10 \times c_1$	$10 \times c_2$	$(g_1^{s_2})^2$	$(g_2^{s_2})^2$	$\rho = -D + 100$

Figure 2 shows the corresponding virtual network, with four paths: $p_1 = (C1, F1, P1, I1, A1)$, $p_2 = (C2, F1, P2, I1, A1)$, $p_3 = (C1, F1, U1)$, $p_4 = (C2, F1, U2)$. The solution yielded from our solution algorithm is given in Table 2. Each path in the virtual transportation network carries a physical meaning in the energy supply chain. For example, path flow on p_1 means the amount of power supplied by firm C1 through wind farm location F1 to demand market A1; path flow on p_3 represents the unused capacity of firm C1 at farm location F1. In addition to path flow, link flow also has a corresponding implication in the energy supply chain. For example, link flow from C1 to F1 represents the total capacity investment by firm C1 at location F1. Using this correspondence, we extract

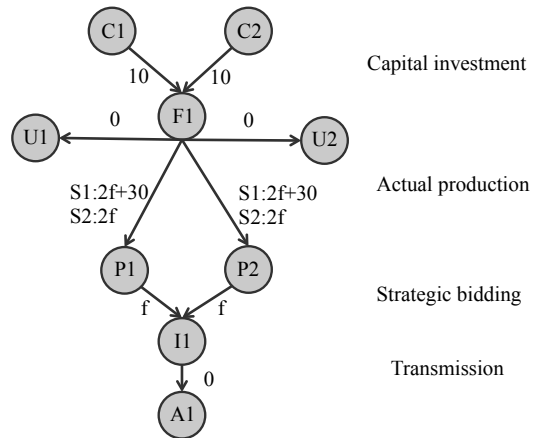

Figure 2: The Virtual Network for Example 1. (Note: the number attached to each arc is the assigned link cost defined in Theorem 2)

the numerical solutions for the energy infrastructure investment problem, as shown in Table 3. These results are consistent with Cournot-Nash equilibrium calculated analytically. The optimal solution to the stochastic multi-agent optimization problem suggests that each firm invest for a generation capacity of 16 units. As a comparison, if the company could wait until future uncertainty is revealed before making investment decision, the deterministic solutions are would be 12 units for scenario 1 and 18 units for scenario 2.

Table 2: Traffic Equilibrium Solutions for the Virtual Network

Items	Scenario 1	Scenario 2	Items	Scenario 1	Scenario 2
p_1	14	16	λ_{U1}	0	20
p_2	14	16	λ_{U2}	0	20
p_3	2	0	λ_{A1}	72	68
p_4	2	0			

Table 3: Power Market Equilibrium Results

Items	Firm 1		Firm 2	
Capacity	16		16	
Generation	$s_1 : 14$	$s_2 : 16$	$s_1 : 14$	$s_2 : 16$
Capacity Shadow Price	$s_1 : 0$	$s_2 : 20$	$s_1 : 0$	$s_2 : 20$
Total Profit	$s_1 : 232$	$s_2 : 672$	$s_1 : 232$	$s_2 : 672$
Expected Profit	452		452	
Whole Sale Price = Retail Price	$s_1 : 72$	$s_2 : 68$		
Consumer Surplus	$s_1 : 392$	$s_2 : 512$		

Table 4 summarizes the numerical implementation details, including the parameter setting, computing environment, and computing time. The convergence pattern of the two scenario-dependent planning decisions is plotted in Figure 3, in which the termination criterion is reached within less than 30 iterations.

Table 4: Numerical Implement Information

Item	Value
PH method parameter γ	1
Computing time	.218s
Computing tools	Matlab 2012b 64 bit (Mac Version)
Computing environment	Mac OSX, 2.3 GHz Intel Core i7, RAM 8GB

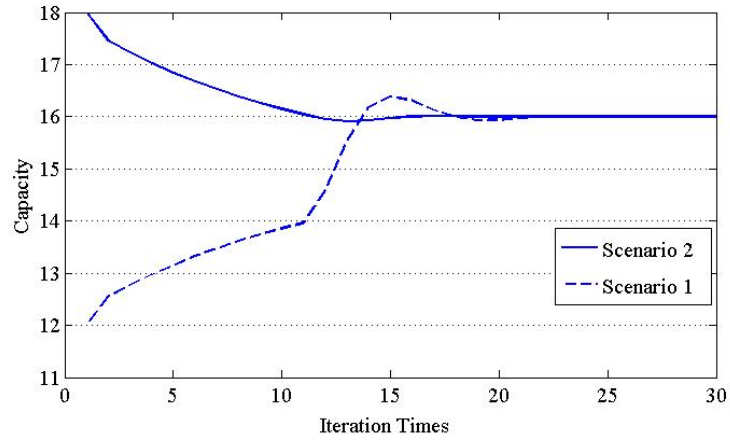

Figure 3: Convergence of the Planning Decision

3.2. A realistic case study based on SMUD power network

To draw meaningful practical implications from the theoretical results reported here, we
 360 implement our model and algorithm on a regional power network in Sacramento Municipal
 Utility District (SMUD). The transmission network consists of 25 nodes, 11 of which are demand
 nodes (Node 1~11), and 65 links. The network structure is shown in Figure 4.

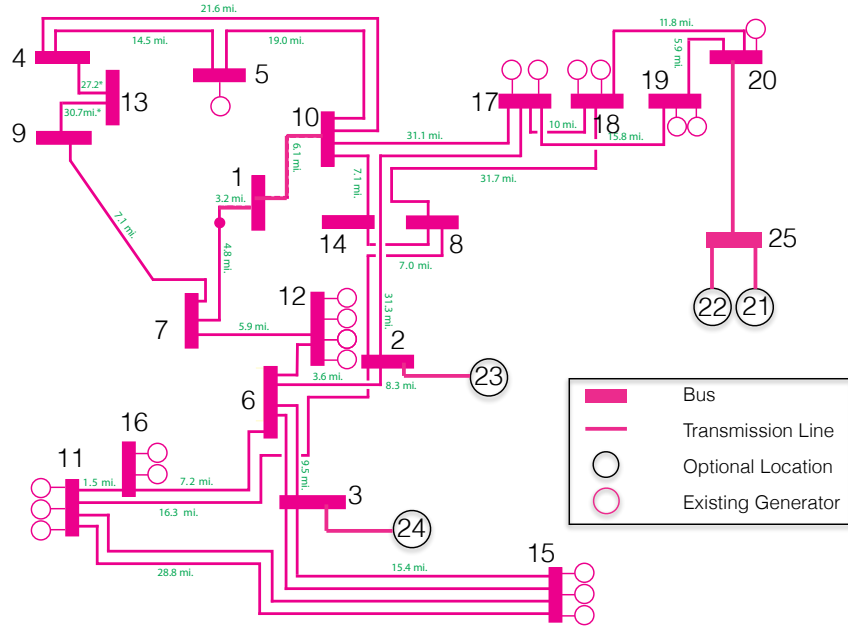

Figure 4: Sacramento Municipal Utility District (SMUD) Network

Four optional investment locations (Node 21~24) are being considered, two of which are in
 remote areas (Node 21 and 22) with lower investment costs but also lower transmission resource;
 365 the other two locations (Node 23 and 24) are just the opposite. The two further locations are
 connected to Node 20 by a single transmission line; the two closer locations are connected to
 Node 2 and 3 via separate transmission lines. We consider two firms with different technologies
 as investors. Firm 2 has mature technologies whose production cost is certain, while Firm 1
 represents emerging technology, whose future production cost is uncertain. We also assume that
 370 the investment cost of one firm is independent of the other firm's decision². The parameter
 values are given in Appendix 2. This setting is referred as base case in the following analysis.

²Symmetric assumption and separable investment cost are not required in our model and algorithm.

An optimal solution is obtained using Algorithm 1 on the same computer as in Example 1, with a total computing time of 3312 seconds. The PH algorithm converges in 13 iterations with an absolute gap of 0.615 (see Figure 5). Each scenario-dependent problem within the PH algorithm is solved using Frank-Wolfe algorithm. See Figure 6 for its convergence pattern³.

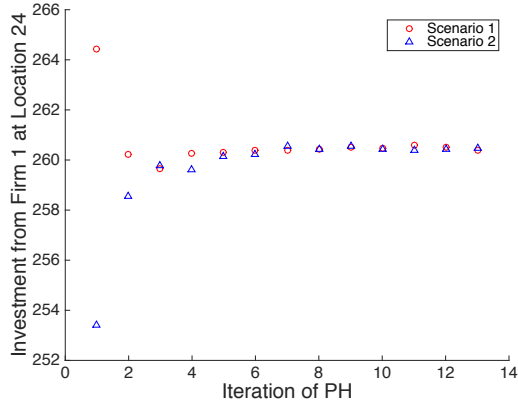

Figure 5: Convergence of PH Algorithm

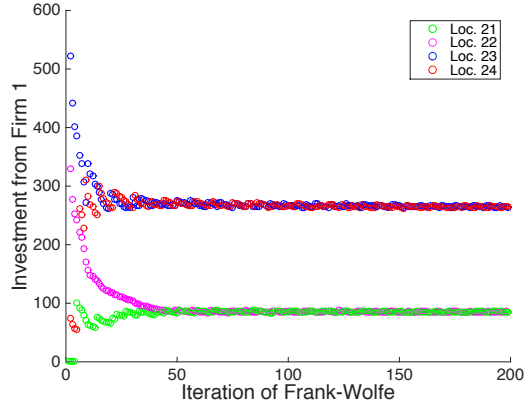

Figure 6: Convergence of Frank-Wolfe Algorithm

In Table 5, we examine the impacts of transmission network on investment decisions by comparing results from two cases: the base case, and the case without considering the transmission network (free-transmission Case). In the base case, both firms invest less in the further locations (location 21 and 22) due to transmission restrictions and costs. However if the transmission network is ignored, the firms would increase their investment in the further locations to take advantage of cheaper capital cost. This comparison shows that ignoring transmission network may lead to poor investment recommendations. Therefore, a supply chain model that captures the essence of transmission network between supplies and demands is critical.

Next, we will use the proposed model to explore the impacts of oligopolistic competition on total investments, average electricity price (see Figure 7), and total system surplus (see Figure 8). The total system surplus is defined as the total consumer willing-to-pay subtracts the total system cost. The consumer surplus is defined as the total consumer benefits subtracts the total electricity bill they pay. Thus we decompose total system surplus into three components: consumer surplus, generators profits (surplus) and transmission revenues⁴. We compare the

³ For the same scenario-dependent problems, PATH, a general-purpose optimization solver for complementarity problems, was unable to obtain solutions.

⁴In this example, ISO is allowed to make short term revenues from transmission services. But eventually, this

Table 5: Impacts of Transmission Network on Investment Decisions

Locations	Base Case		Free-transmission Case	
	Firm 1	Firm 2	Firm 1	Firm 2
21	84.0	84.2	217.1	215.1
22	84.0	83.3	216.9	214.7
23	260.2	258.8	215.9	213.8
24	260.5	258.4	215.9	214.0
Total	688.6	684.7	865.8	857.5

390 results among three market types (cases): the base case, monopoly case (only Firm 2) and perfect-competition case. From Figure 7, with more competition involved in power supply side, lower electricity price and higher total investment can be expected. This is mainly due to the fact that electricity generally has low price elasticity of demand. Lacking competition will make supplier exert market power by strategically withholding their investment (long term) and manipulate the market price (short term). From Figure 8, we can see that as market competition level increases, the total system surplus increases, the transmission revenues increases and the generator surplus decreases to zero. These results demonstrate that an energy planning model capturing oligopoly market is critical - simplifying an oligopolistic electricity market to either a central-planner case or a perfect market case would compromise the long-term investment decisions and thus the total system surplus.

400

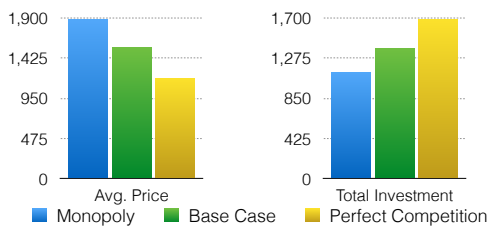

Figure 7: Impacts of Strategic Behavior on Price and Investment

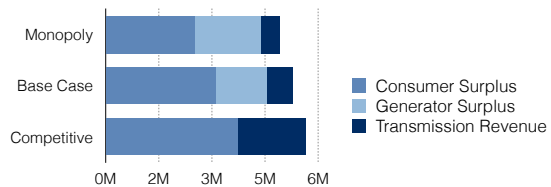

Figure 8: Impacts of Strategic Behavior on Total System Surplus

Finally, we explore the impacts of uncertainty. In Table 6, we compare results from the stochastic model (base case) and a deterministic approach. The deterministic approach takes the

revenue will be used for transmission investment so that ISO keeps long term profit neutral.

expected value of Firm 1’s production cost as model input, in which case the two firms become symmetric. The results show that when there is no uncertainty about future technology, both firms reduce their investment. This is somehow counter intuitive because it is generally believed that uncertainty discourages industry from investing. We think the results observed here is due to combined effects of oligopoly market and uncertainty. In an oligopoly market, firms have market power to influence the price so that the market price is always larger than the marginal production (plus marginal capital) cost. Since the firms are allowed to adjust their production quantities in the operational stage (second stage of stochastic programming), they can always maintain a non-negative profit in each scenario. Therefore, firms are more “optimistic” when they make the first stage investment decisions - with uncertainty about future production cost, both firms will focus more on the good scenario for themselves. However, if the firms take a more risk-averse attitude instead of a risk-neutral one, we expect to have different results. We also observe that investment at cheaper locations are more sensitive to uncertainty, indicated by the last column in Table 6. The intuition is that when facing future technology/productivity uncertain, a firm is more likely to favor cheaper locations to compensate its potential risk.

Table 6: Comparing Investment Decisions between Stochastic and Deterministic Approach

Locations	Base Case		Case 4		Changes	
	Firm 1	Firm 2	Firm 1	Firm 2	Firm 1	Firm 2
21	84.0	83.7	80.3	79.9	4.6%	4.7%
22	84.0	83.3	80.8	80.2	4.1%	3.8%
23	260.2	258.8	257.7	257.3	1.0%	0.6%
24	260.5	258.4	257.2	257.1	1.3%	0.5%
Total	688.6	684.2	675.9	674.6	1.9%	1.4%

4. DISCUSSION

This study focuses on renewable energy infrastructure planning in the context of an electricity supply chain. The main contribution is on the development of modeling and solution methods to address challenges brought by uncertainties and oligopolistic competition among energy producers over a complex network structure. Through using stochastic decomposition and variational inequalities, we show that the stochastic energy supply chain planning problem can be converted

to multiple scenario-dependent traffic equilibrium problems. This analysis allowed us to exploit
425 efficient solution techniques developed by the transportation research community, resulting in
greater numerical performance than directly using general-purpose optimization solvers.

There are several directions for future research. One may explore the roles of risk attitudes
and information quality on energy infrastructure investment strategies, which may be used to
design efficient information sharing strategy across stakeholders in the system. In addition,
430 with the connections established between the energy planning and traffic network equilibrium
problems, one may extend the rich knowledge generated in the transportation literature to energy
modeling. For example, knowledge about price of anarchy, congestion pricing, and dynamic
equilibrium may be extended to energy system planning and policy related questions, such
as how to influence individual energy investment decisions from user-optimal to system-optimal
435 through economic incentives. We hope the work reported here will inspire more interdisciplinary
research across transportation and energy.

References

- Bar-Gera, H., 2010. Traffic assignment by paired alternative segments. *Transportation Research Part B* 44, 1022–1046.
- 440 Birge, J.R., Louveaux, F., 2011. *Introduction to stochastic programming*. Springer.
- Bushnell, J.B., Mansur, E.T., Saravia, C., 2007. *Vertical Arrangements, Market Structure, and Competition An Analysis of Restructured US Electricity Markets*. Technical Report. National Bureau of Economic Research.
- CalISO, 2013. About us. URL: <http://www.caiso.com/about/Pages/default.aspx>.
- 445 Cournot, A.A., Fisher, I., 1897. *Researches into the Mathematical Principles of the Theory of Wealth*. Macmillan Co.
- Day, C.J., Hobbs, B.F., Pang, J.S., 2002. Oligopolistic competition in power networks: a conjectured supply function approach. *Power Systems, IEEE Transactions on* 17, 597–607.
- Genc, T.S., Reynolds, S.S., Sen, S., 2007. Dynamic oligopolistic games under uncertainty: A
450 stochastic programming approach. *Journal of Economic Dynamics and Control* 31, 55–80.
- Hearn, D.W., Yildirim, M.B., 2002. *A toll pricing framework for traffic assignment problems with elastic demand*. Springer.

- Hu, X., Ralph, D., Ralph, E.K., Bardsley, P., Ferris, M.C., 2004. Electricity generation with looped transmission networks: Bidding to an ISO. Department of Applied Economics, University of Cambridge.
455
- IEA, 2006. Wind Energy Annual Report. Technical Report. International Energy Association.
- Jofre, A., Wets, R., 2014. Variational convergence of bifunctions: Motivating applications. SIAM Journal of Optimization (to appear) .
- Kagiannas, A.G., Askounis, D.T., Psarras, J., 2004. Power generation planning: a survey from monopoly to competition. International journal of electrical power and energy systems 26,
460 413–421.
- LeBlanc, L.J., M.E.P.W., 1975. An efficient approach to solving the road network equilibrium traffic assignment problem. Transportation Research 9, 309–318.
- Lew, D., Piwko, R., 2010. Western wind and solar integration study. National Renewable Energy
465 Laboratories, Technical Report No. NREL/SR-550-47781 .
- Liu, Z., Nagurney, A., 2007. Financial networks with intermediation and transportation network equilibria: a supernetwork equivalence and reinterpretation of the equilibrium conditions with computations. Computational Management Science 4, 243–281.
- Liu, Z., Nagurney, A., 2009. An integrated electric power supply chain and fuel market network
470 framework: Theoretical modeling with empirical analysis for new england. Naval Research Logistics 56, 600–624.
- Liu, Z., Nagurney, A., 2011. Supply chain outsourcing under exchange rate risk and competition. Omega 39, 539–549.
- Liu, Z., Nagurney, A., 2013. Supply chain networks with global outsourcing and quick-response
475 production under demand and cost uncertainty. Annals of Operations Research 208, 251–289.
- Louveaux, F., 1986. Discrete stochastic location models. Annals of Operations research 6, 21–34.
- Matsypura, D., Nagurney, A., Liu, Z., 2007. Modeling of electric power supply chain networks with fuel suppliers via variational inequalities. International Journal of Emerging Electric Power Systems 8.

- 480 Nagurney, A., 2006. On the relationship between supply chain and transportation network equilibria: A supernetwork equivalence with computations. *Transportation Research Part E-Logistics and Transportation Review* 42, 293–316.
- Nagurney, A., 2014. *Supply Chains and Transportation Networks*. Springer Berlin Heidelberg. chapter 47. pp. 787–810.
- 485 Nagurney, A., Liu, Z., Cojocaru, M.G., Daniele, P., 2007. Dynamic electric power supply chains and transportation networks: an evolutionary variational inequality formulation. *Transportation Research Part E: Logistics and Transportation Review* 43, 624–646.
- Nagurney, A., Matsypura, D., 2007. A supply chain network perspective for electric power generation, supply, transmission, and consumption. Springer. pp. 3–27.
- 490 Pineau, P.O., Murto, P., 2003. An oligopolistic investment model of the finnish electricity market. *Annals of Operations Research* 121, 123–148.
- Rinaldi, S.M., Peerenboom, J.P., Kelly, T.K., 2001. Identifying, understanding, and analyzing critical infrastructure interdependencies. *Control Systems, IEEE* 21, 11–25.
- Rockafellar, R., 1976. Augmented lagrangians and applications of the proximal point algorithm in convex programming. *Mathematics of operations research* 1, 97–116.
- 495 Rockafellar, R.T., Wets, R.J.B., 1991. Scenarios and policy aggregation in optimization under uncertainty. *Mathematics of operations research* 16, 119–147.
- Willems, B., Rumiantseva, I., Weigt, H., 2009. Cournot versus supply functions: What does the data tell us? *Energy Economics* 31, 38–47.

Algorithm 2 PH-Transportation Network Sub-Function

```

function RECOVER DECISION(path flow  $\chi$ , travel disutility  $\lambda$ )
     $f_a \leftarrow \sum_{p \in P} x_p \delta_{ap}, \forall a \in L$  ▷ get link flow
     $\mathbf{c} \leftarrow \mathbf{f}_{C-F}$  ▷ get investment decision
     $\mathbf{g} \leftarrow \mathbf{f}_{F-P}$  ▷ get production decision
     $\rho, \lambda_c \leftarrow \lambda$  ▷ get electricity price and capacity shadow price
    return ( $\mathbf{c}, \mathbf{g}, \rho, \lambda_c$ )
end function

```

Appendix 2: Data for Example 2

Table 7: Capacity Cost Data

Node #	Firm 1	Firm 2
21	$24.3 \times c_1$	$24.3 \times c_2$
22	$24.3 \times c_1$	$24.3 \times c_2$
23	$46.1 \times c_1$	$46.1 \times c_2$
24	$46.1 \times c_1$	$46.1 \times c_2$

Table 8: Generation Cost Data

Scenario #	Firm 1	Firm 2	Probability
1	$110 \times g_1$	$60 \times g_2$	0.5
2	$10 \times g_1$	$60 \times g_2$	0.5

Table 9: Demand Function Parameters d_b and d_a (Demand Function is $d = -d_a * w + d_b$)

Node	1	2	3	4	5	6	7	8	9	10	11
Intercept (d_b)	202	78	318	167	180	277	293	183	148	363	333
Slope (d_a)	-0.075	-0.196	-0.048	-0.091	-0.085	-0.055	-0.052	-0.083	-0.103	-0.042	-0.046

Table 10: Transmission Capacity c_t (link transmission cost function is $\phi_t = 10 * [1 + (v/c_t)^4]$)

Link #	From Node	End Node	Capacity	Link #	From Node	End Node	Capacity
1	1	7	307	34	8	2	309
2	1	10	319	35	11	2	478
3	2	6	319	36	6	3	478
4	2	8	309	37	6	3	319
5	2	11	478	38	5	4	289
6	3	6	478	39	10	4	467
7	3	6	319	40	13	4	319
8	4	5	289	41	10	5	319
9	4	10	467	42	12	6	319
10	4	13	319	43	9	7	319
11	5	10	319	44	12	7	319
12	6	12	319	45	14	8	744
13	7	9	319	46	13	9	319
14	7	12	319	47	14	10	638
15	8	14	744	48	15	11	638
16	9	13	319	49	15	11	638
17	10	14	638	50	15	3	638
18	11	15	638	51	15	3	478
19	11	15	638	52	6	16	478
20	3	15	638	53	11	16	319
21	3	15	478	54	17	2	319
22	16	6	478	55	17	10	303
23	16	11	319	56	17	19	331
24	2	17	319	57	17	18	319
25	10	17	303	58	8	18	303
26	19	17	331	59	20	18	309
27	18	17	319	60	20	19	307
28	18	8	303	61	21	25	1000
29	18	20	309	62	22	25	1000
30	19	20	307	63	23	2	400
31	7	1	307	64	24	3	400
32	10	1	319	65	25	20	300
33	6	2	319				